

# Installation Instruction

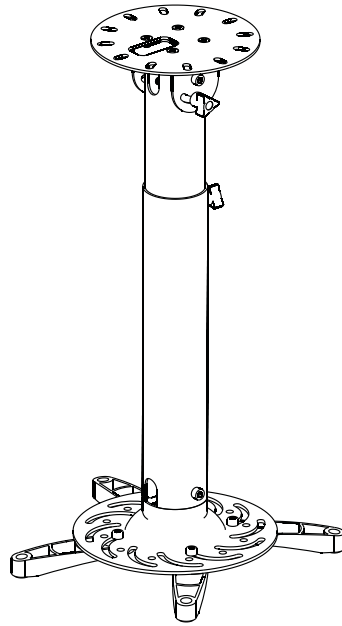

## UNPACKING INSTRUCTIONS

- Carefully open the carton, remove contents and lay out on cardboard or other protective surface to avoid damage.
- Check package contents against the Supplied Parts List in the next page to assure that all components were received undamaged. Do not use damaged or defective parts.
- Carefully read all instructions before attempting installation.

## IMPORTANT SAFETY INFORMATION

Install and operate this device with care. Please read this instruction before beginning the installation, and carefully follow all instructions contained herein. Use proper safety equipment during installation.

Please call a qualified installation contractor for help if you:

- If you don't understand these directions or have any doubts about the safety of the installation.
- If you are uncertain about the nature of your ceiling, consult a qualified installation contractor.

Do not use this product for any purpose or in any configuration not explicitly specified in this instruction. We hereby disclaims any and all liability for injury or damage arising from incorrect assembly, incorrect mounting, or incorrect use of this product.



**WARNING**

## CAUTION!

This projector mount must be securely attached to the ceiling. If the mount is not properly installed it may fall, resulting in possible injury and/or damage.

**Tools Required**

■ 3.8mm Drill Bit

■ 8mm Masonry Bit

■ Phillips Screwdriver

**Note:** The mounting components and hardware supplied in this package are not designed for installations to ceiling with steel studs or to cinder block . If the hardware you need for your installation is not included, please consult your local hardware store for proper mounting hardware for the application.

## Supplied Parts List

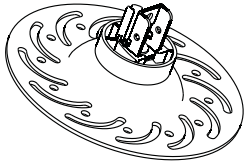

(1) Projector Plate-a

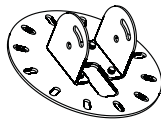

(1) Ceiling Plate-b

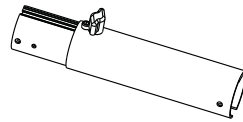

(1) Tube Set-c

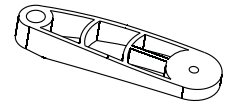

(4) Mounting Legs-d

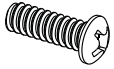

(4) M3x16 Bolt-e

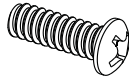

(4) M4x12 Bolt-f

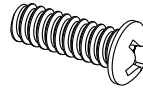

(4) M5x12 Bolt-g

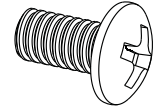

(4) M6x12 Bolt-h



(4) M3/M4 Washer-i

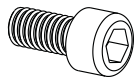

(4) M6x16 Hexangular Head Bolt-j

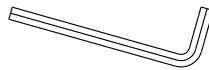

(1) Allen Wrench-k



(3) Lag Bolt-l

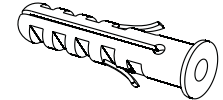

(3) Concrete Anchor-m

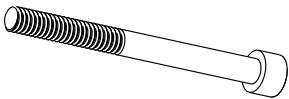

(1) Longer Bolt-n



(1) Nut-o

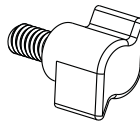

(2) Plastic Knob-p

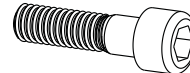

(2) M6x22 Hexangular Head Bolt-q



(4) M3x10 Bolt-r

### Selecting the Proper Mounting Hardware

1. Invert the projector and locate the mounting points.
2. Test each size of the screws provided.
3. The correct screws should thread easily into the mounting point and not pull out when pressure is applied.



DO NOT OVER-TIGHTEN YOUR MOUNTING SCREWS TO THE PROJECTOR CHASSIS. USING THE INCORRECT SCREW DEPTH MAY CAUSE DAMAGE TO YOUR PROJECTOR.

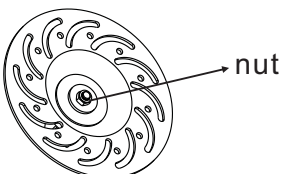

## ATTENTION

You can tighten this nut if you want to make the big tilting for your projector. But please don't over-tighten, otherwise you may have problem to do the tilting.

## Step 1

### Install the Mounting Legs on the Projector

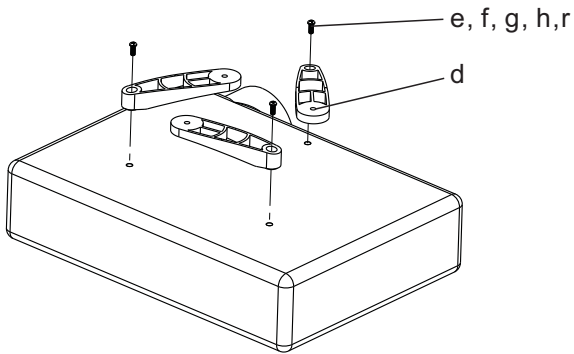

1. Locate the mounting points on the bottom of the projector.
2. Attach the appropriate number of Mounting Legs(d) to the projector using the appropriate mounting Bolts(e,f,g,h,r).
3. Do not tighten these bolts completely at this time.
4. The M3/M4 Washers(i) have to be used if you use the M3/M4 bolts.

## Step 2

### Install the Projector Plate to the Mounting Legs

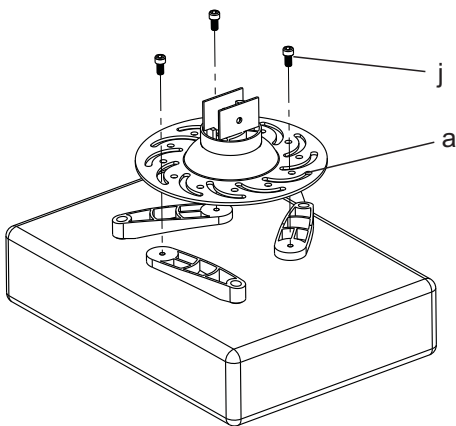

1. Align the Projector Plate(a) to the mounting legs.
2. Position the legs accordingly for best configuration. You may raise or lower each leg independently.
3. Secure the legs to the projector plate by screwing M6x16 Hexangular Head Bolt(j) (do not over-tighten) on the mounting legs, using the Allen Wrench(k) provided.
4. Tighten all bolts at this time.

## Step 3

### Install the Ceiling Plate to the Ceiling

#### Concrete Ceiling

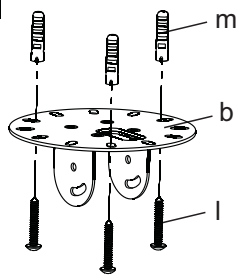
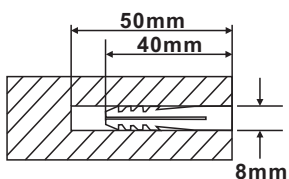

Use the Ceiling Plate(b) as a template to mark 3 hole locations on the ceiling. Pre-Drill these holes with a 8mm masonry bit to at least 50mm in depth. Insert a Concrete Anchor(m) into each of these holes. Make sure the anchor is seated completely flush with the concrete surface even if there is a layer of drywall or other material in front. Attach the ceiling plate to the ceiling using 3 pieces Lag Bolts(l) and 3 pieces Concrete Anchor(m).

#### Wood Stud Ceiling

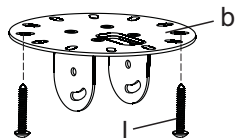
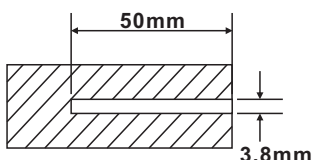

Use a stud finder to locate the stud. It is a good idea to verify where the stud is located with an awl or thin nail. Pre-drill a 50mm deep hole at the stud using a 3.8mm drill bit. Make sure the hole is in the center area of the stud. Use the Ceiling Plate(b) as a template to mark the location of the second hole in the stud. Drill 50mm deep hole using the 3.8mm drill bit in the marked location. Attach the ceiling plate to the ceiling using the 2 pieces Lag Bolts(l).

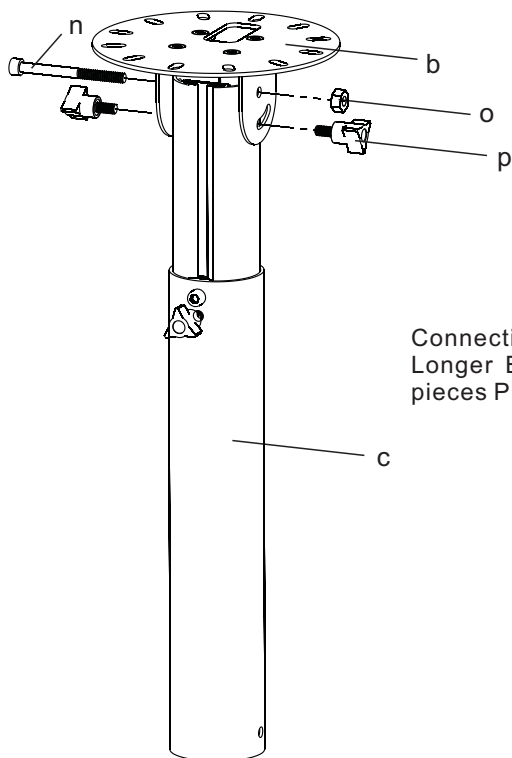
**Step 4****Connecting Tube Set to Ceiling Plate**

Connecting the Tube Set(c) and Ceiling Plate(b) by one piece Longer Bolt(n) and one piece Nut(o) as the picture, install two pieces Plastic Knob(p) on the tilting slot of ceiling plate.

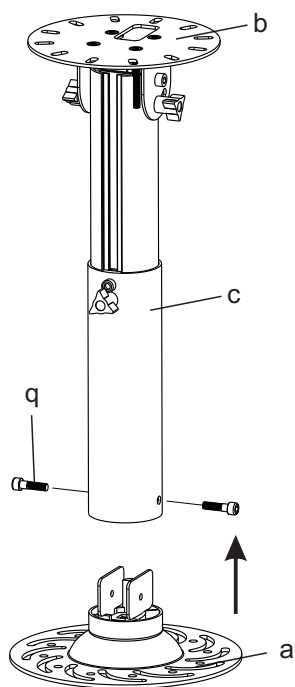
**Step 5****Connecting the Tube Set to Projector Plate**

Connecting the Tube Set(c) and Projector Plate(a) by two M6x22 bolt(q) as the picture.

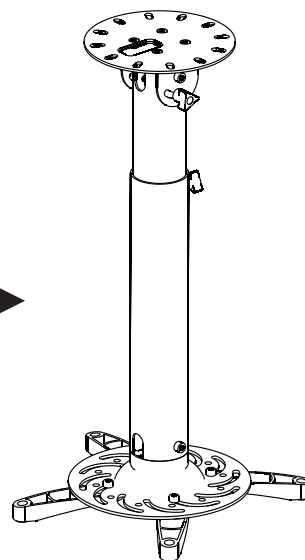

**Thanks for choosing our products, enjoy the using.**