

Assembly Instructions for Speaker Stand

Safety Warning: If you do not understand these directions, or have any doubts about the safety of the installation, please call a qualified contractor. Check carefully to make sure there are no missing or defective parts. Never use defective parts. Improper installation may cause damage or serious injury. Do not use this product for any purpose that is not explicitly specified in this manual. We can not be liable for damage or injury caused by incorrect mounting, incorrect assembly, or incorrect use.

Note: We makes every effort to assure all necessary Speaker Stand hardware is included. If the hardware you need is not included please consult your local hardware store.

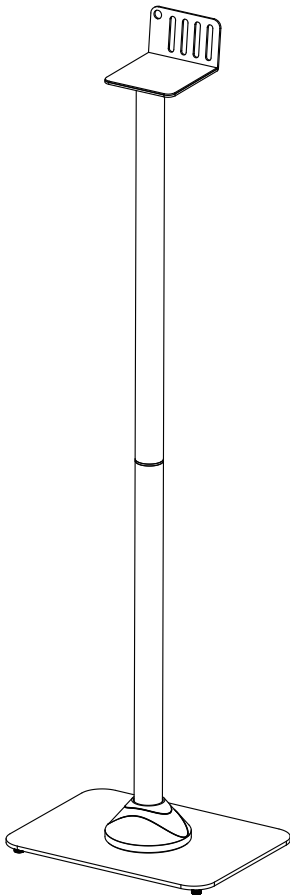





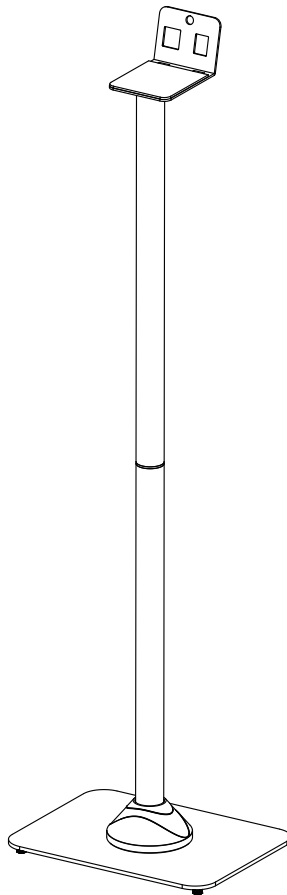

**PLAY 3:
Horizontal Bracket**

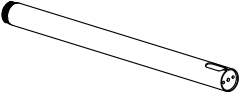

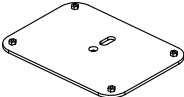
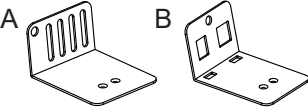
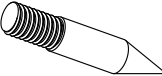
**PLAY 3:
Vertical Bracket**

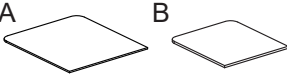

Supplied Parts

No.	Picture	Description	Quantity
1		Pole	2
2		Pole Connector	1
3		Stand Base	1
4		Speaker Bracket	1
5		Nylon Pads	4
6		Plastic Knob	4
7		Decorative Cover	1
8		M5X10 Countersink Bolt	2
9		M6X12 Countersink Bolt	1
10		M6X14 Speaker Bolt	1
11		Soft Pad	1

Step 1

Install Speaker Bracket onto One Pole

1.1a: Horizontal

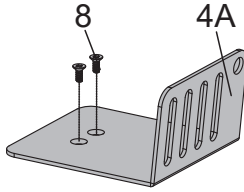
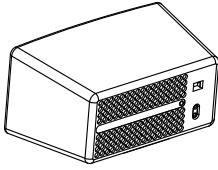

1.1b: Vertical

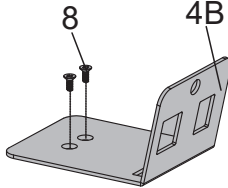
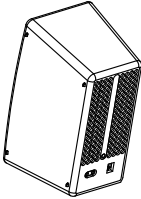

1.2a: Horizontal

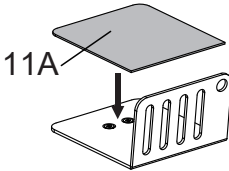

1.2b: Vertical

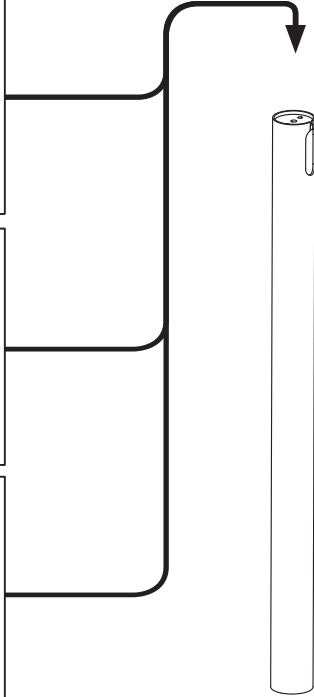
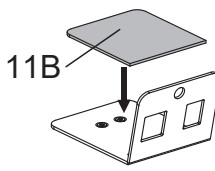

Step 2

Connect the two Poles by Pole Connector

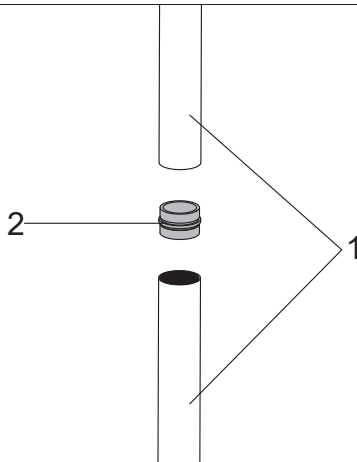

Step 3

Route Speaker Stand Cord

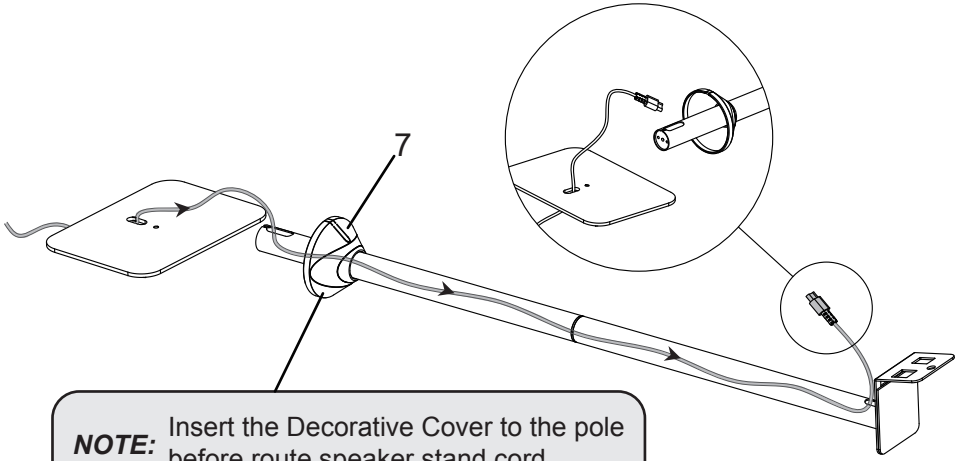

NOTE: Insert the Decorative Cover to the pole before route speaker stand cord.

Step 4

Connect Stand Base to the Pole by M6X12 Countersink Bolt

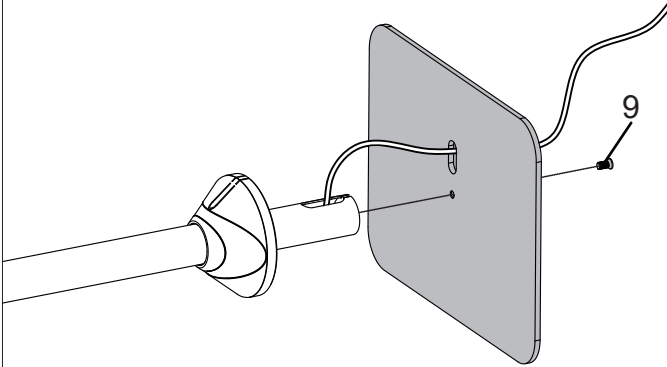

NOTE:

When fasten the M6X12 Countersink Bolt, please make sure the wire route hole on top pole facing the right back of Stand Base.

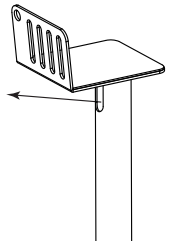

Step 5 Install Nylon Pads or Carpet Spikes

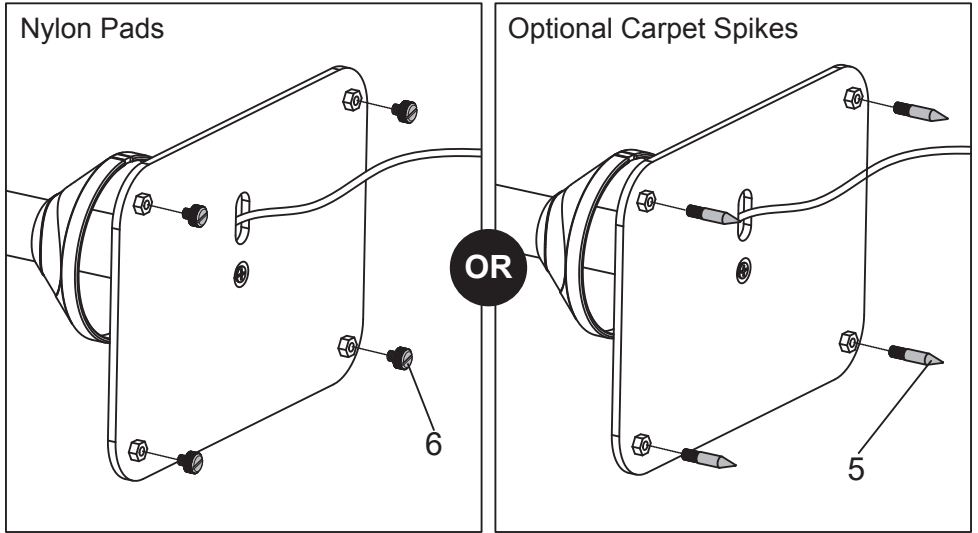

Step 6 Install the SONOS PLAY 3 to the Speaker Bracket

