

Installation Instruction

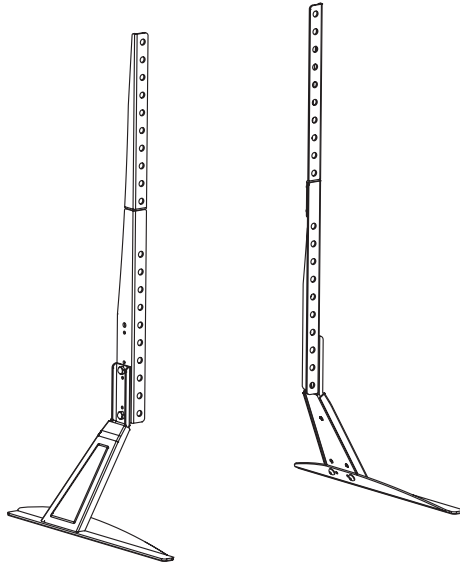

UNPACKING INSTRUCTIONS

- Carefully open the carton, remove contents and lay out on cardboard or other protective surface to avoid damage.
- Check package contents against the Supplied Parts List in the next page to assure that all components were received undamaged. Do not use damaged or defective parts.
- Carefully read all instructions before attempting installation.

IMPORTANT SAFETY INFORMATION

Install and operate this device with care. Please read this instruction before beginning the installation, and carefully follow all instructions contained herein. Use proper safety equipment during installation.

Please call a qualified installation contractor for help if you:

- If you don't understand these directions or have any doubts about the safety of the installation.
- If you are uncertain about the nature of your wall, consult a qualified installation contractor.

Do not use this product for any purpose or in any configuration not explicitly specified in this instruction. We hereby disclaim any and all liability for injury or damage arising from incorrect assembly, incorrect mounting, or incorrect use of this product.

Supplied Parts List

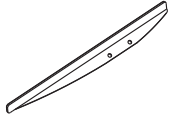

(1)Base Plate-a1

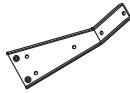

(1)Junction Plate-a2

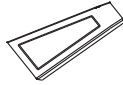

(1)Plastic Cover-a3

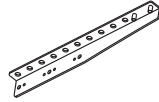

(1)TV Bracket1-a4

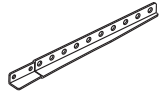

(1)TV Bracket2-a5



(1)Base Plate-b1

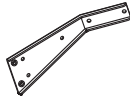

(1)Junction Plate-b2

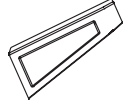

(1)Plastic Cover-b3

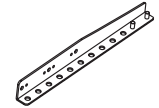

(1)TV Bracket1-b4

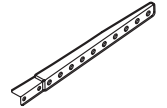

(1)TV Bracket2-b5



(8)M6x10 Bolt
Allen Head



(4)M6 Nut1



(4)M6 Nut2



(1)Allen Key

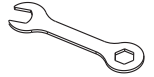

(1)Wrench



(4)M4 Spacer-A



(8)5mm M6/M8
Spacer-B

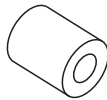

(4)20mm M6/M8
Spacer-C

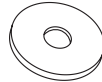

(4)M4 Washer-D

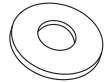

(4)M6 Washer-E



(4)M8 Washer-F



(4)M4x12 Bolt-G



(4)M4x30 Bolt-H



(4)M6x20 Bolt-J



(4)M6x35 Bolt-K



(4)M8x20 Bolt-L

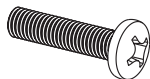

(4)M8x35 Bolt-M

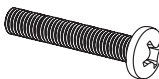

(4)M8x45 Bolt-N

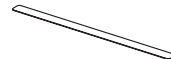

(2)Soft Pad

Step 1

Connecting the Base Plates and Junction Plates

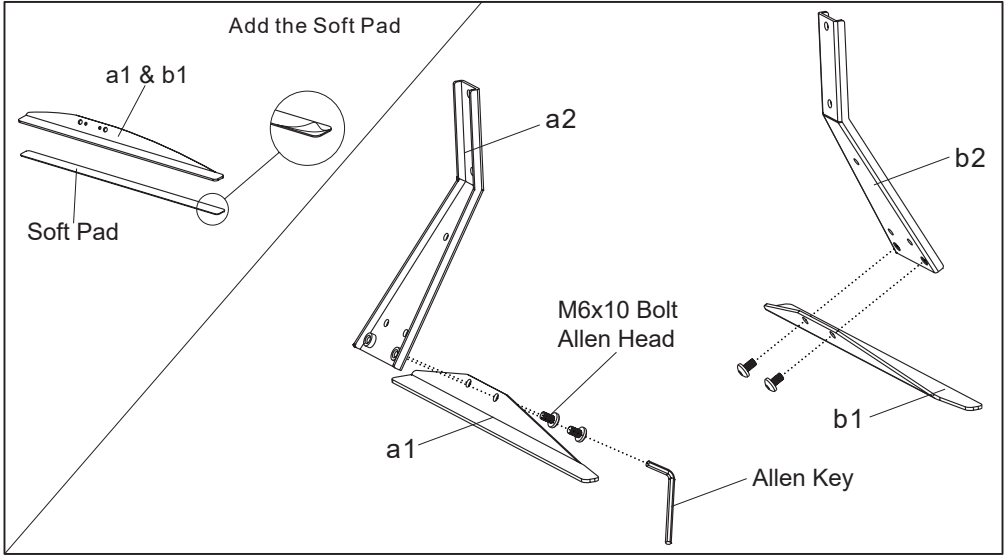

Step 2

Connecting the Vertical Monitor Brackets

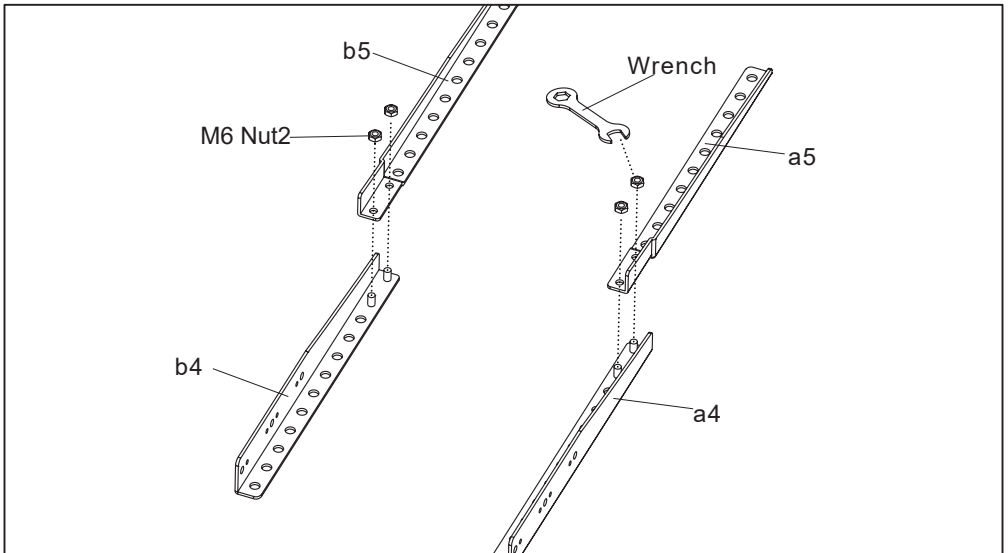

Step 3

Connecting the TV Brackets and Junction Plates, then install the Plastic Covers

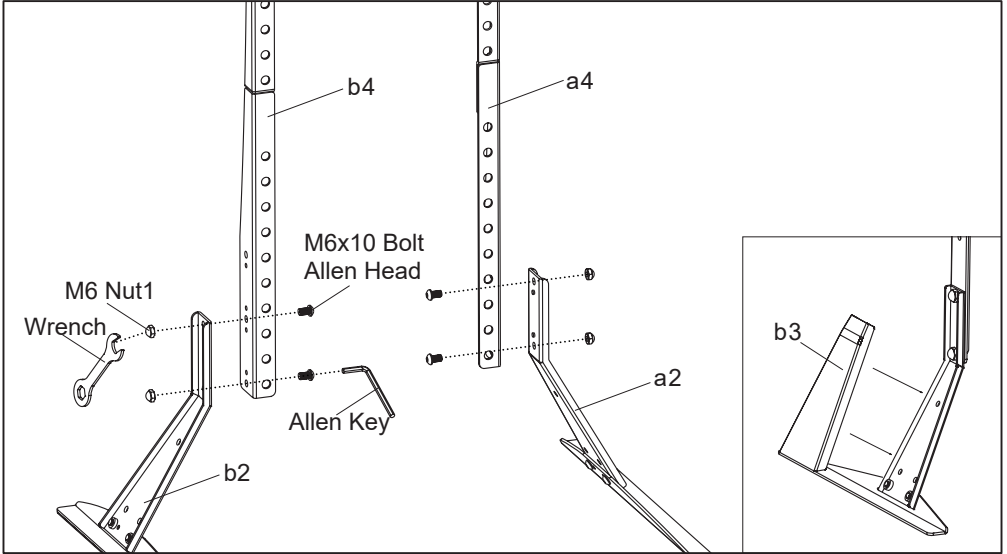

Step 4

Attaching the TV Brackets to the back of TV

